

SA13S  
SA13W  
SA13B  
SA13PB

Installation Instructions

# SYSTEMA

Systema | Monitor Arm | 130mm

## Component Checklist

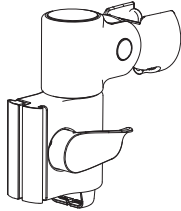

Arm Assembly

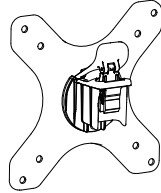

VESA monitor head



Display Mounting  
Spacers (x4)



M4 x 14mm (x1)  
Silver Phillips Head  
Security Screw

### HARDWARE

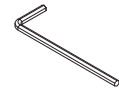

3mm Allen Key

### Display Mounting Screws



M4 x 12/16/25mm (x4)  
Black Phillips Head Mounting Screws

## IMPORTANT INFORMATION:

**! IMPORTANT - Install Systema Monitor Arm as per installation instruction.**

! This product supports a maximum load of 12kg (26.4lbs).

! The manufacturer accepts no responsibility for incorrect installation.

! The Systema Monitor Arm is compatible with Systema Posts: SP10, SP40, SP75 and with Wall Channels: SW6 & SW35.

## Step 1. Check Components

Check what you have received against the component checklist and hardware above.

## Step 2. Mount Arm Assembly

### 2.1 Remove Post Top Cap.

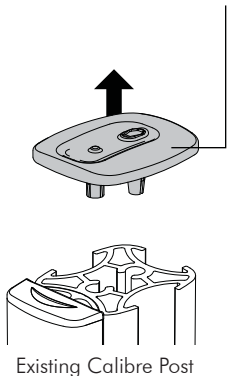

### 2.2 Insert Arm Assembly into Channel

**Note:** Squeeze and hold Clamp Head before inserting into the channel on Post Assembly or Wall Channel.

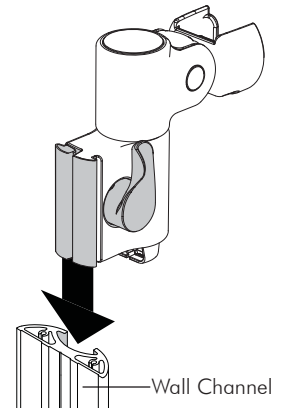
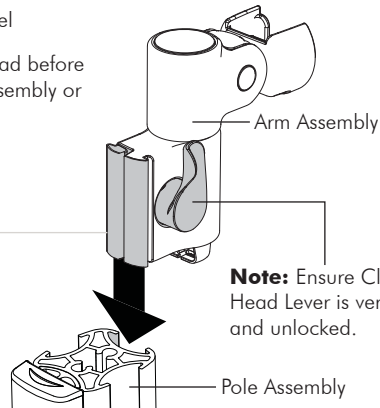
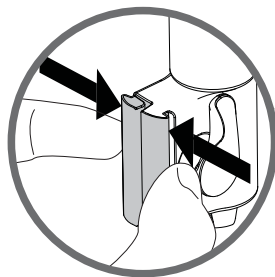

### 2.3 Move Channel Clamp to desired height.

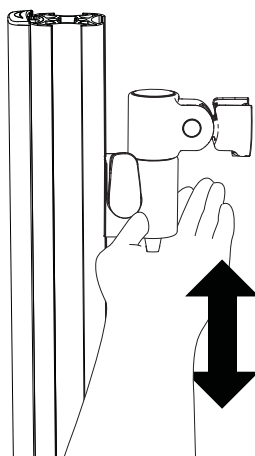

### 2.4 Lock Channel Clamp at preferred height.

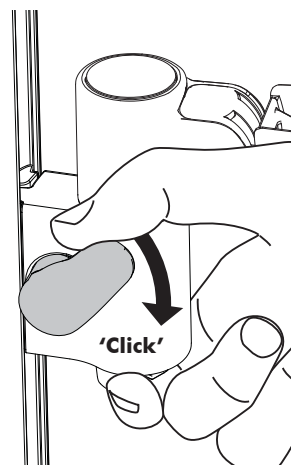

### 2.5 Insert Post Top Cap into Post Assembly.

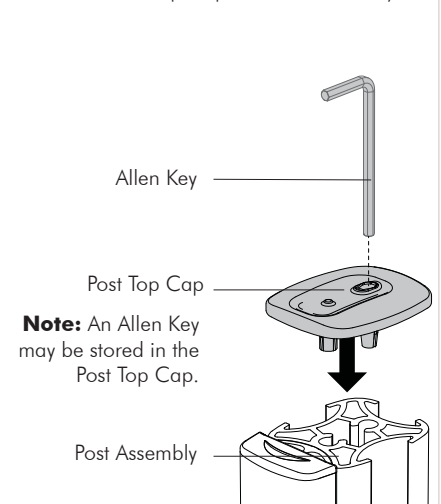

### Step 3. Install VESA monitor head

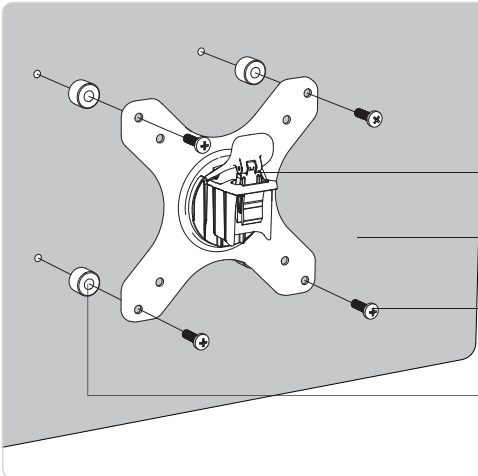

**3.1** Install VESA monitor head as shown.

VESA monitor head

Screen

M4x12/16/25mm Phillips Head Mounting Screws

Spacers (may be required for recessed and uneven surfaces)

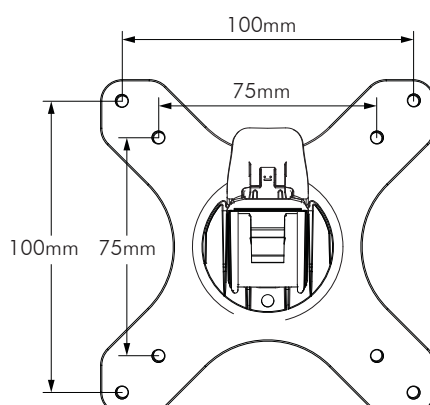

100mm

75mm

100mm

75mm

### Step 4. Mount Display

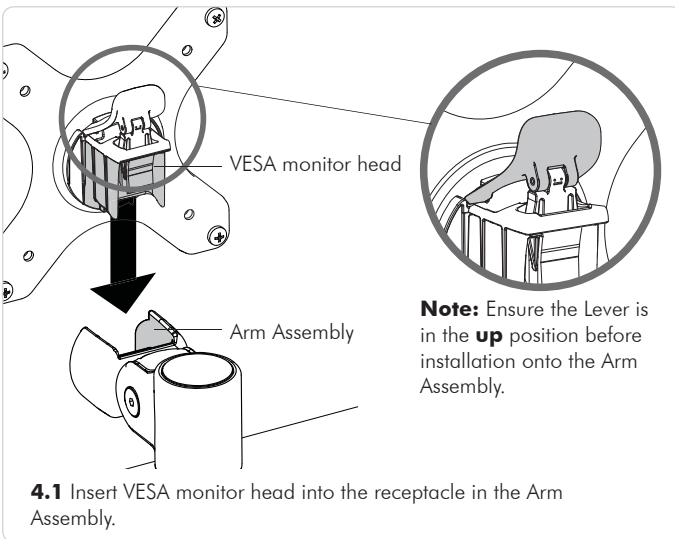

VESA monitor head

Arm Assembly

**Note:** Ensure the Lever is in the **up** position before installation onto the Arm Assembly.

**4.1** Insert VESA monitor head into the receptacle in the Arm Assembly.

**4.2** Ensure that the VESA monitor head sits flush within the Arm Assembly receptacle. There should be **no** gap.

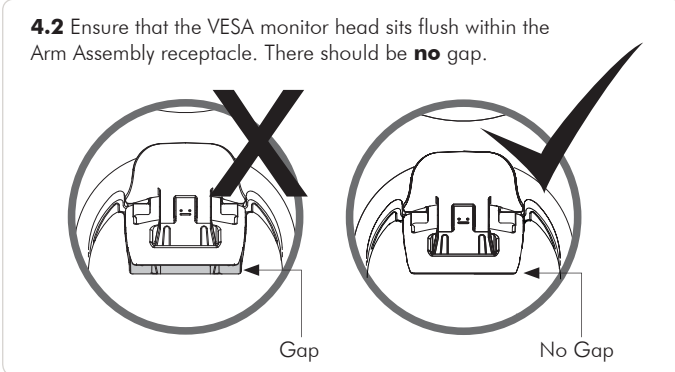

Gap

No Gap

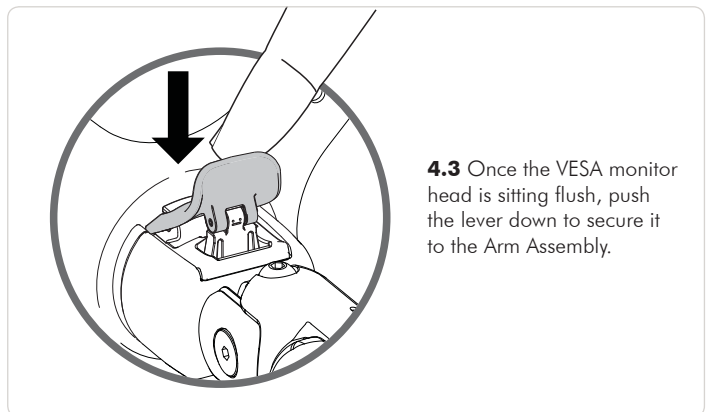

**4.3** Once the VESA monitor head is sitting flush, push the lever down to secure it to the Arm Assembly.

**Note:** Support Screen when adjusting tilt.

**4.4** OPTIONAL SECURITY SCREW  
Ensure the Monitor is supported, then loosen the Monitor head screw with the 3mm Allen Key and tilt screen up before installing the M4 x 14mm Security Screw into the Security Screw hole.

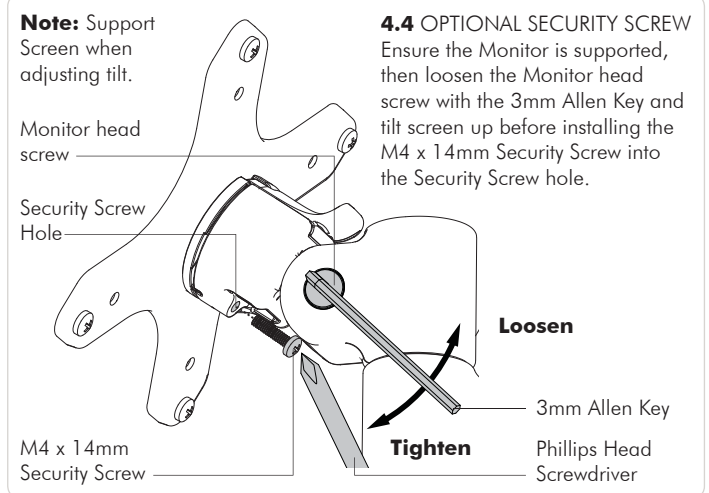

Monitor head screw

Security Screw Hole

Loosen

3mm Allen Key

Tighten

M4 x 14mm Security Screw

Phillips Head Screwdriver

### Step 5. Cable Management

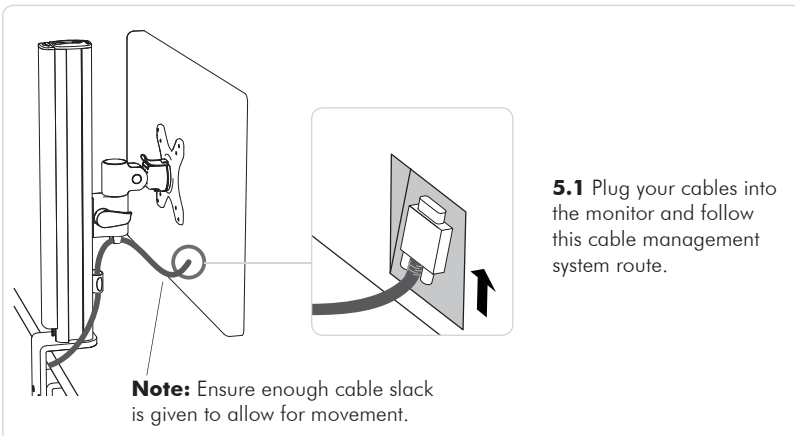

**5.1** Plug your cables into the monitor and follow this cable management system route.

**Note:** Ensure enough cable slack is given to allow for movement.

**5.2** Under the Channel Clamp, pull one side of the clip down and push the cable through the gap.

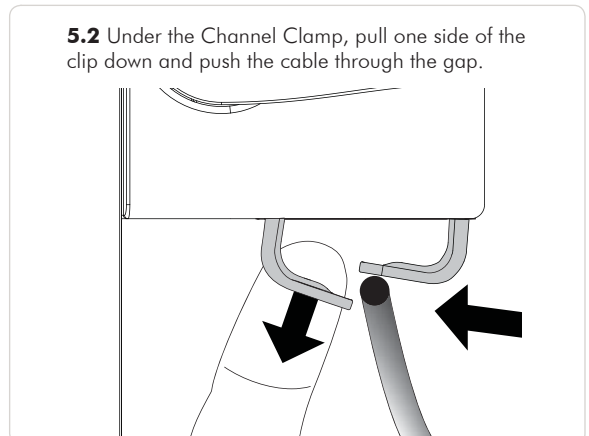

## Step 5. Cable Management (cont.)

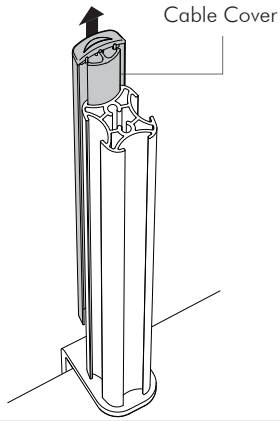

**Note:** The Cable Cover shown, only comes with SP40 or SP75 posts.

### 5.3 OPTIONAL

To reposition the Cable Cover, pull it straight up and out of the post and insert it into any of the available channels.

### Optional Cable Cover Positions

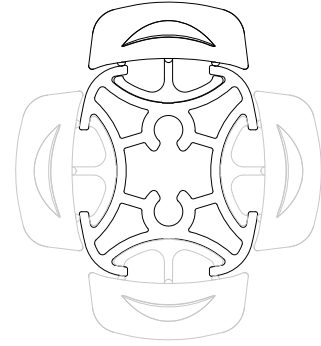

**Note:** Choose 5.4 and/or 5.5 for your column cable management depending on your needs.

### 5.4 OPTIONAL

**A.** Loop cable and insert into Cable Cover.

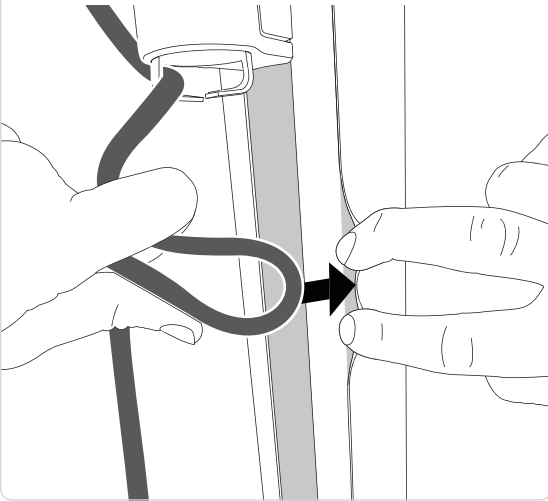

### 5.4 OPTIONAL

**B.** Push the Cable down into either side of the Cable Cover until it reaches the bottom.

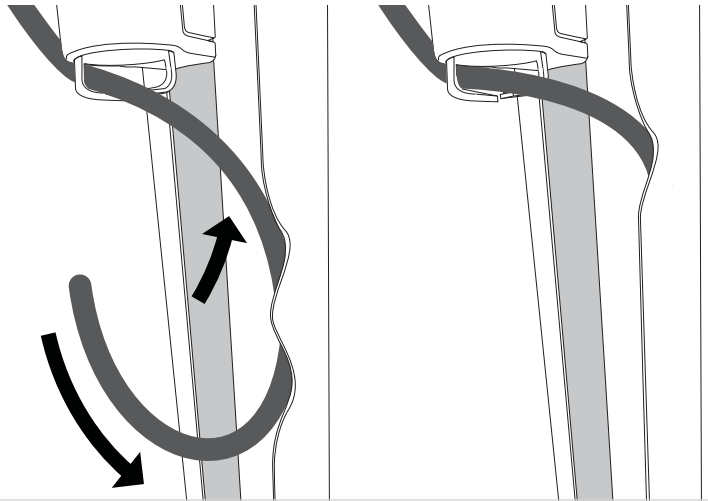

**5.5 OPTIONAL (NOTE: Cable clips only come with SP40 and SP75 Posts or separately in SC4 accessory pack)**

**A.** Push the cable down into the Cable Clip.

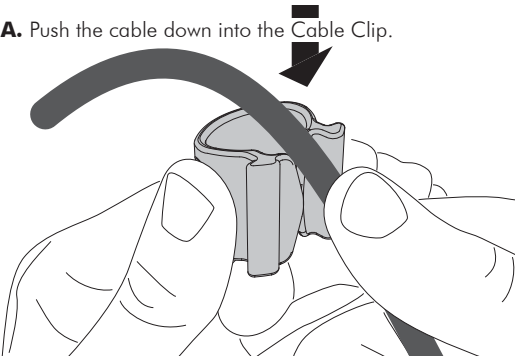

### 5.5 OPTIONAL

**B.** Insert one side of the Cable Clip into the Channel on the Post assembly or Wall channel, before pushing the other side in.

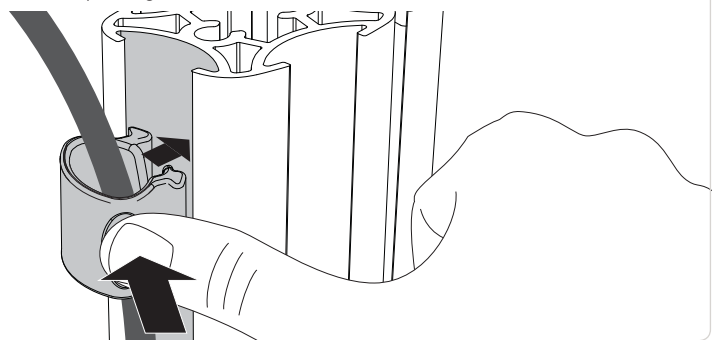

**For a triple configuration Atdec recommends using:**

Post Cable Cover

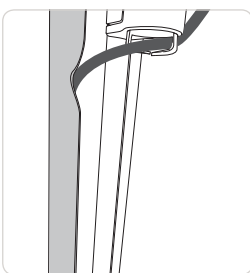

Post Cable Cover

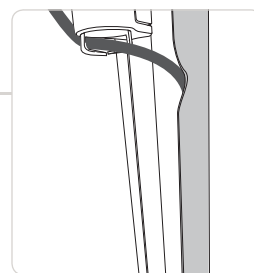

Post Cable Clip

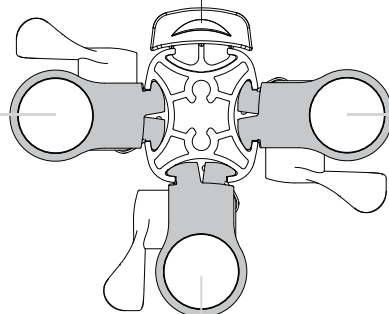
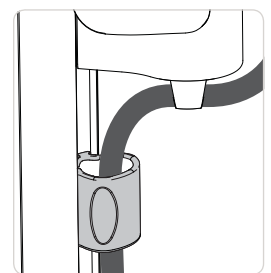

## Step 6. Adjusting the Display Bracket

### Portrait/Landscape

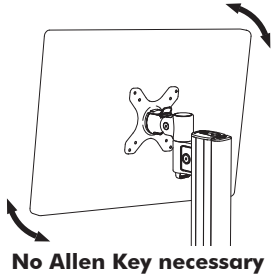

### Tilt (Screen angle up/down)

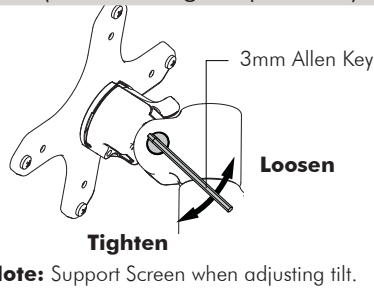

### Pan (Screen angle left/right)

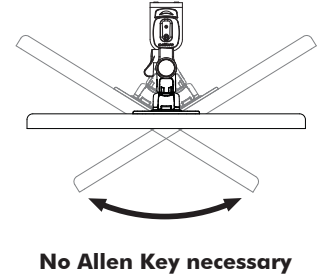

## Ergonomic Guidelines

Many experts believe that the extended use of any computer screen has the potential to cause serious injury to your eyes, neck and back. This can be largely avoided by correctly positioning your display.

**Viewing angle:** Ergonomists recommend that the optimal position of your display should be slightly below eye level. When looking at the display's centre the user should have a downward visual angle of approximately 10°-20°.

**Height:** As a guide, the height (**h**) of your display should approximately be as follows:

- Tall Male (Max): 560mm (22")
- Short Male (Min): 368mm (14.5")
- Tall Female (Max): 520mm (20.5")
- Short Female (Min) 356mm (14")

**Distance:** For visual comfort, a viewing distance (**d**) between 500mm (20") to 750mm (29.5") is recommended.

**Tilt Angle:** Angular adjustments to reduce reflection on your monitor should range between 5° forward tilt to 15° backward tilt.

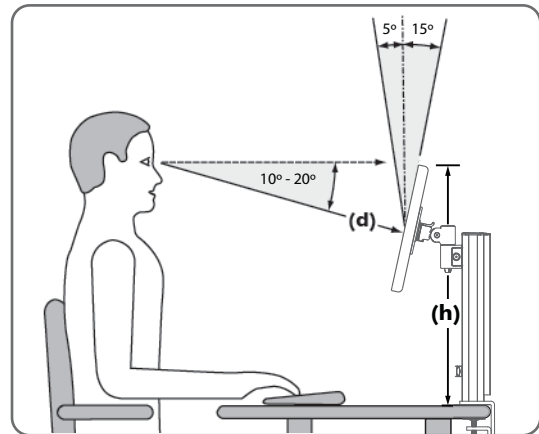

## Installation Complete



No portion of this document or any artwork contained herein should be reproduced in any way without the express written consent of Atdec Pty Ltd. Due to continuing product development, the manufacturer reserves the right to alter specifications without notice. Published 06.11.14 ©